

INSTALLATION

MANUAL

for DAS Energy Modules

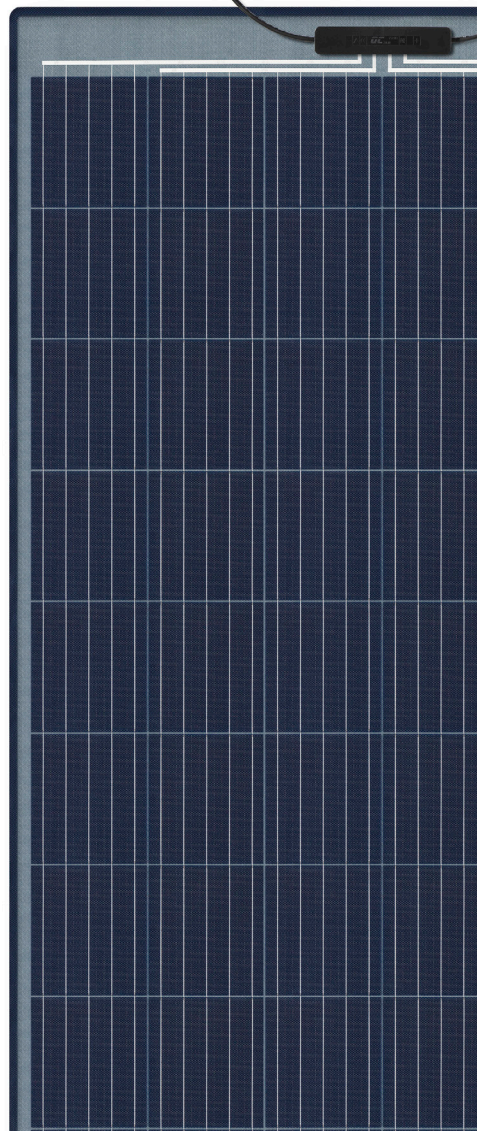
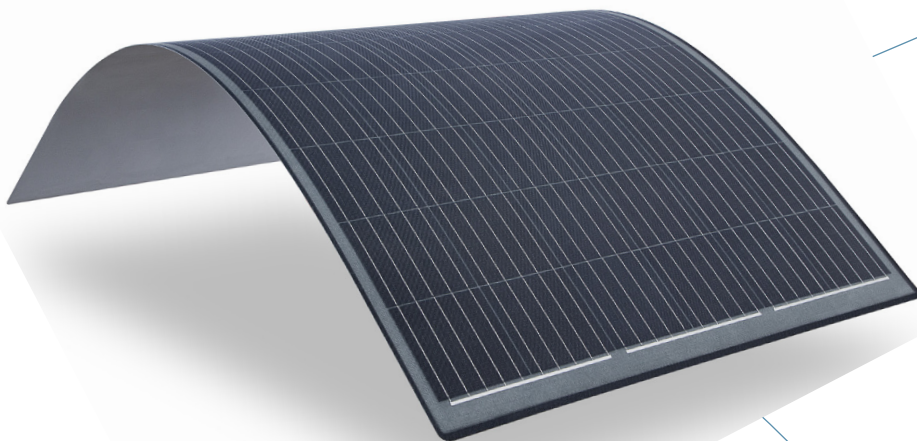

WARNING

Compliance with the Installation Instructions is a prerequisite for the applicability of the Limited Warranty provided by DAS Energy. Non-compliance with the present Installation Instructions and the subsequent damage might therefore revoke the Limited Warranty provided by DAS Energy.

TABLE OF CONTENTS

I.	GENERAL INFORMATION	3
	PRODUCT TYPE DESIGNATION AND APPLICABLE PRODUCTS	3
	IMPORTANT NOTES	4
	DISCLAIMER	4
II.	SAFETY INSTRUCTIONS	5
	HANDLING OF THE MODULES	5
	ELECTRICAL SAFETY	6
III.	INSTALLATION REQUIREMENTS	7
	INSTALLATION POSITION AND WORKING ENVIRONMENT	7
	MODULE LAYOUT	8
IV.	MODULE INSTALLATION	9
	MOUNTING VIA BONDING	9
	MOUNTING OF MODULES WITH MOUNTING HOLES	10
V.	ELECTRICAL INSTALLATION	11
	SYSTEMCOMPONENT DIMENSIONING	11
	INVERTER	12
	CABLES AND WIRING	12
	CONNECTORS	13
	CABLE TRAYS	16
	EARTHING / LIGHTNING PROTECTION	16
VI.	OPERATION AND MAINTENANCE	17
	VISUAL INSPECTION	17
	CLEANING	17
	MODULE REPLACEMENT / DISMANTLING	17
VII.	DISPOSA	19
VIII.	POTENTIAL SOURCES OF FAULTS	19
IX.	TECHNICAL DETAILS	20
	PRODUCT MARKING, PRODUCT LABEL	20
	SAFETY APPLICATION CLASS	20
	FIRE SAFETY CLASS	20
	MODULE SPECIFICATIONS	20
	DECLARATION OF CONFORMITY	23

I. GENERAL INFORMATION

Thank you for purchasing a DAS Energy product. Our photovoltaic modules are built using our patented innovative technology and top-quality materials.

The following guidelines have been provided to avoid mistakes when installing the modules. Only trained specialists should conduct the static calculations, planning and subsequent installation of solar modules, including their permitted substructure. They must be familiar with the applicable laws and ordinances of the respective country and with the special regulations for photovoltaic systems. Exceeding or undercutting of the permissible loads, such as wind and snow loads will render the warranty void. In addition to the following instructions, we recommend to use, follow and respect IEC 62548 ("Photovoltaic arrays – design requirements").

PRODUCT TYPE DESIGNATION AND APPLICABLE PRODUCTS

The DAS Energy PV modules are designated according to the respective number of cells and the position of the junction box:

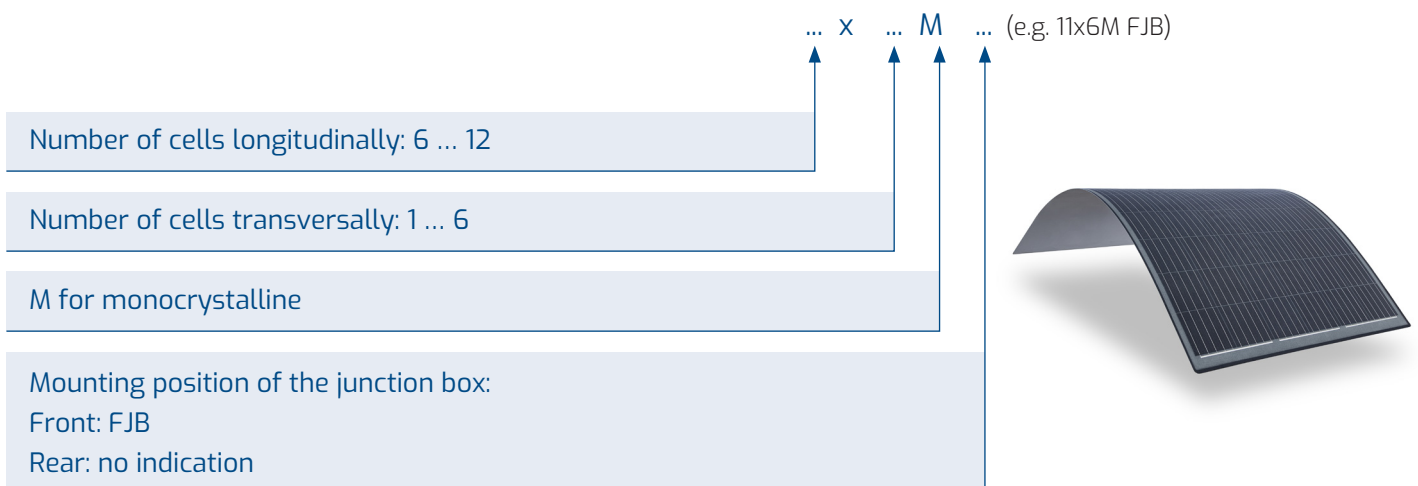

This installation manual is applicable to the PV module types as listed below:

DAS ENERGY PV MODULE											
6x1M RJB	6x1M FJB	6x2M RJB	6x2M FJB	6x3M RJB	6x3M FJB	6x4M RJB	6x4M FJB	6x5M RJB	6x5M FJB	6x6M RJB	6x6M FJB
7x1M RJB	7x1M FJB	7x2M RJB	7x2M FJB	7x3M RJB	7x3M FJB	7x4M RJB	7x4M FJB	7x5M RJB	7x5M FJB	7x6M RJB	7x6M FJB
8x1M RJB	8x1M FJB	8x2M RJB	8x2M FJB	8x3M RJB	8x3M FJB	8x4M RJB	8x4M FJB	8x5M RJB	8x5M FJB	8x6M RJB	8x6M FJB
9x1M RJB	9x1M FJB	9x2M RJB	9x2M FJB	9x3M RJB	9x3M FJB	9x4M RJB	9x4M FJB	9x5M RJB	9x5M FJB	9x6M RJB	9x6M FJB
10x1M RJB	10x1M FJB	10x2M RJB	10x2M FJB	10x3M RJB	10x3M FJB	10x4M RJB	10x4M FJB	10x5M RJB	10x5M FJB	10x6M RJB	10x6M FJB
11x1M RJB	11x1M FJB	11x2M RJB	11x2M FJB	11x3M RJB	11x3M FJB	11x4M RJB	11x4M FJB	11x5M RJB	11x5M FJB	11x6M RJB	11x6M FJB
12x1M RJB	12x1M FJB	12x2M RJB	12x2M FJB								

IMPORTANT NOTES

- Please make sure that you have read and understood all the safety information in this installation guide before installing and operating the modules.
- Please observe all local, regional, national, and international legal provisions, guidelines, standards, and regulations, as well as the guidelines on work safety from the employer's liability insurance associations.
- Assembly, installation, and initial operation of the modules requires expert knowledge and must only be carried out by qualified and authorized professionals.
- The modules must be checked for mechanical integrity before installation. Damaged modules must not be installed.
- The modules almost produce full voltage also under bad lighting conditions, even when they are not connected to an electric current, i.e. caution is always advised during installation with regard to electrical faults e.g. short circuits.
- The real output power produced by the modules can be above the specified nominal power. The given nominal power is determined according to industry standard at 1,000 W/m² radiation intensity and 25 °C solar cell temperature. In practical operation the current intensity, voltage and resulting power produced by the module can increase as a result of colder ambient temperatures or the reflection from snow, water, or other reflective surfaces.
- Avoid focusing light and directing it onto the module.
- Only use devices, connectors and cables which are suitable for use with photovoltaic systems.
- Please observe all safety measures and instructions for other components used.

DISCLAIMER

DAS Energy cannot control the use of this safety, installation, and instruction manual or the conditions and procedures for installing, operating, using, and maintaining the modules. Therefore, DAS Energy assumes no responsibility and expressly disclaims liability for loss, damage, injuries, casualties, or expense arising out of or in any connection with installation, operation, use or maintenance of the modules. Any modifications or any use of DAS Energy products contrary to their specifications and not expressly authorized by DAS Energy will result in a loss of any liability claims. The information in the manual is based on the knowledge and experience of DAS Energy and is considered to be accurate and reliable. However, information, product specifications and suggestions have neither the explicit nor implicit nature of a guarantee. DAS Energy reserves the right to modify its products, the technical specifications and installation instructions without notice.

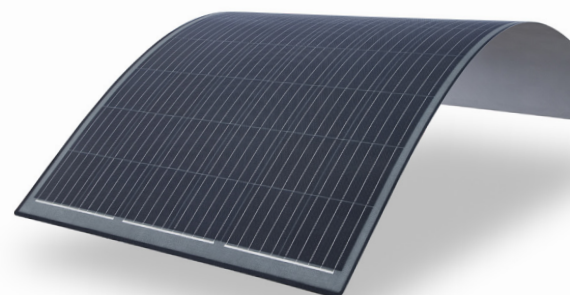

II. SAFETY INSTRUCTIONS



Make sure to read through and observe the following safety instructions, in order to avoid personal injuries and damages on the modules under all circumstances.

HANDLING OF THE MODULES

The correct handling of DAS Energy modules is essential for the durability of the product. Therefore, the most important notes on proper handling of the modules are listed below.

- Do NOT attempt to transport, handle, or install the modules by yourself without a second person. Transport, handling, and installation of the modules should be done by at least two persons.
- Do NOT bend or snap the modules (remark: the modules are flexible but should only be bent when finally mounted on a round mounting base).
- Do NOT place the modules on the corners nor on the edges!
- Do NOT apply forces while laying the modules down (do not throw the module).
- Do NOT apply focused pressure on the modules in order to avoid punctures, cuts, or tears.
- Do NOT step on the modules (depending on the underground the modules can eventually be damaged).
- Do NOT lean the modules on sharp or spiky objects.
- Do NOT drop heavy or sharp objects onto the modules.
- Do NOT use the junction box or the connection cable as a help for handling.
- Do NOT cut or pierce the module as this may cause live components to be exposed and/or damage the module.
- Do NOT bend or apply excessive force to the cables.
- Do NOT stack modules (the junction box shall not be in contact with the front surface, because the sharp edges of the junction box may damage the front surface).
- Do NOT scratch or hit the module frontside or the backsheet.
- Do NOT apply paint, varnish, or protective coatings to the modules.
- Do NOT dismantle or remove any part or label attached by the manufacturer.
- Do NOT open the original packaging during transportation and storing until installation. At the same time, please protect the packaging from damage and store the packages securely in a ventilated, cool, and dry room until installation. The packaging is not weather-proof.
- Do NOT attempt to repair a damaged module.
- Do NOT concentrate sunlight (e.g. mirrors or lenses) or other sources of artificial light on the modules.
- Do NOT use photovoltaic modules in the presence of inflammable or explosive substances.

Maximum bending: DAS Energy modules are flexible, but they cannot be rolled-up or folded. Poly- and monocrystalline modules may be bent up to a maximum radius of 2.000 mm (only the long side of the module should be bent). Smaller radii are not permitted. Excessive bending must be avoided when handling the modules. The maximum bending mentioned should be understood only for one-time bending to permanently mount the modules on round surfaces. The modules are not designed to withstand such maximum bending radius for applications where bending occurs repeatedly or periodically. The bending process must be done uniformly as punctual bending may cause permanent damage to the cells. The modules should not be held only on the short ends or corners as this may cause excessive bending under their own weight.

Not following those points may cause single PV cells to break inside the module or injure the protective layer of the composite! Mishandling of the module may lead to a decrease of the performance or aspect of the modules, for which DAS Energy shall not be held liable.

ELECTRICAL SAFETY

- This product generates electricity when the front side is exposed to light, even when it is not connected to an electric circuit. Even if voltage and current from a single PV module are low, touching terminals or wiring may cause shocks or burns. These risks increase when many modules are installed together as several modules together generate voltages and currents which are dangerous and could be lethal! DAS Energy will not be held responsible in any way for accidents and damage to persons, including electric shock, caused by incorrect use or installation.
- In practical operation the current intensity, voltage and resulting power produced by the DAS Energy PV module can increase as a result of colder ambient temperatures or the reflection from snow, water, or other reflective surfaces.
- The PV modules do not have an on/off switch. The modules can be rendered inoperative only by removing them from the sunlight, by fully covering their front surface with opaque material or by working with the module face down on a smooth, flat surface.
- In order to avoid arcs and electric shock, never disconnect the electrical connections under load. Faulty connections can also result in arcs and electrical shock. Therefore, unconnected connectors must always be protected from pollution (e.g. dust humidity, foreign particles, etc.), prior to installation (the modules are supplied with protective dust caps on the PV4-5 connectors). Do not leave unconnected (unprotected) connectors exposed to the environment and ensure that they are in proper working condition (leaving the unconnected modules without the protective dust caps will render the warranty void).
- Please do not moisten or clean the sockets, cables, or connectors with oily, greasy, or alcohol-based substances, when they are soiled. Never insert metal objects into the connector or modify them in any way in order to secure an electrical connection. Never open or remove the junction box.
- Work only under dry conditions and use only dry tools with insulated grips. Do not handle PV modules when they are wet unless wearing appropriate protective equipment. If it is required to clean the modules, please follow the instructions for cleaning in this manual (refer to VI. Operation and maintenance: Cleaning). Do by no means touch wet connectors without wearing appropriate protective equipment or rubber gloves.
- Do not use damaged photovoltaic modules (damaged during transport or installation). In case a PV module is damaged in any manner (damaged PV laminate, junction box, cables, or connectors), please wear personal protection equipment and separate the module from the circuit. Do not attempt to repair a damaged module.

III. INSTALLATION REQUIREMENTS

INSTALLATION POSITION AND WORKING ENVIRONMENT

- Before installing the PV modules on a roof, ensure that the roof construction is suitable. The modules have been certified for a maximum wind suction load of 2,400 Pa and a maximum snow load or wind pressure of 5,400 Pa.
- Before installing the PV modules via bonding, ensure that the substrate is suitable and approved for bonding (refer to List of tested and approved substrates in Bonding instructions, Art. no. 199131-2, p. 26). In case the substrate is not listed, please consult DAS Energy for further clarification.
- The modules must not be installed in locations where they could be submerged in water for lengthy periods of time.
- The limit operating temperature should be within -40 °C to 85 °C.
- It must be ensured, that the modules are not subjected to wind or snow loads exceeding the maximum permissible loads.
- The modules should be installed in such a way that there is no shading throughout the year. It must be ensured that there is no obstacle or other roof structure which can cause partial or complete shadowing of the modules.
- Do not use modules near equipment or in locations where flammable gasses may be generated or collected.
- The modules must not be installed nor operated in areas where hail, snow, sand, dust, air pollution, soot, etc., are excessive and exceed the tested intensity according to IEC 61215 and IEC 61730. Furthermore, the modules must not be installed nor operated where aggressive substances or chemically active vapors, acid rain, or any other type of corrosive agent could affect the safety and/or performance of the modules. When the modules are installed or operated at locations where there is heavy snow, extremely cold, strong wind, salt fog, or high stress caused by sand and dust, appropriate measures to ensure the performance and safety of the modules must be adopted.
- The operations of installation and maintenance of the photovoltaic modules must take place only under dry conditions.
- Check if any permits and / or concessions are necessary by your current applicable legislation before installation.

Disclaimer: DAS Energy is not liable for any damage to persons, to the substrate/roof, the PV system (including the PV modules as well as the cabling and cable trays) or any other object affected by the installation of the PV system arising from non-observance of any applicable legislation or of the guidelines and instructions in this manual, such as non-compliance with the site requirements, improper module allocation, improper cabling or improper positioning/fixing of the cable trays.

MODULE LAYOUT

The module layout should be planned by a qualified professional. Hereby all local and regional requirements and provisions must be observed. Fig. 1 and Fig. 2 show a typical module layout. In order to avoid damage due to linear thermal expansion of the modules and the substrate a minimum distance of 5 mm for synthetic roofing membranes or respectively 10 mm for bituminous roof sheetings must be observed between adjacent PV modules. In the longitudinal direction, every two modules there should be a space for the cable tray and a footpath. The distance of 500 mm as given in this example has only recommending character.

Fig. 1:
Exemplary module layout for flat roofs (module type 11x6M FJB) – overview

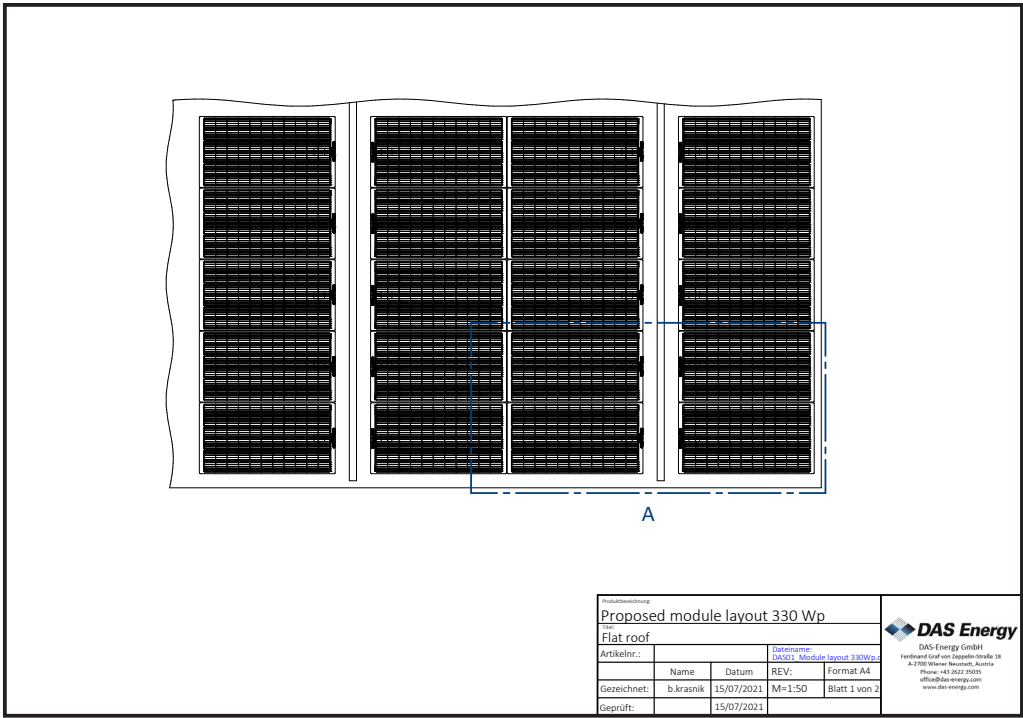
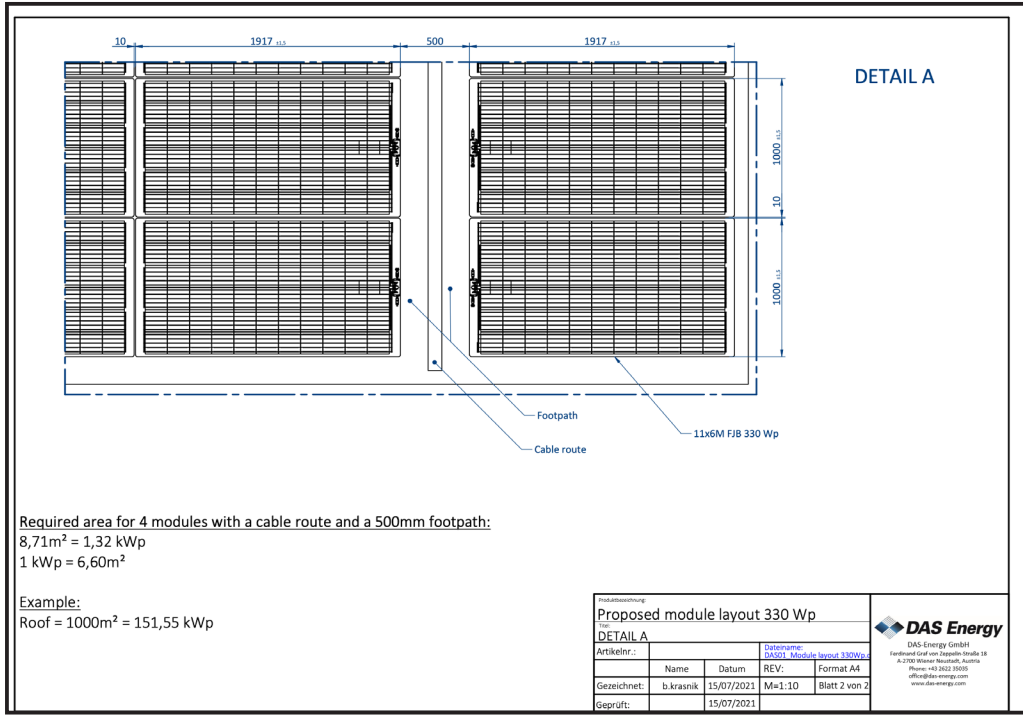

Fig. 2:
Exemplary module layout for flat roofs (module type 11x6M FJB) – detailed view



IV. MODULE INSTALLATION



During installation, the installer must unconditionally follow the general rules for safety at work, the rules for electrical installation and devices, the local applicable construction rules and all other regional and national rules and regulations.

DAS Energy modules are typically mounted via bonding, either directly on a substrate or, if necessary, on a supporting sub-construction. The bonding method depends on the material and the properties of the substrate. Alternatively, the modules can also be bolted, e.g. to a metal sub-construction, by means of holes or eyelets in the module edge zones.

MOUNTING VIA BONDING

The PV modules can be mounted in landscape or portrait orientation. In any case, the adhesive beads must be applied in water flow direction. Identify and, if possible, leave out recurring sources of dirt and avoid shading sources. Install the cable tray at a distance of at least 10 mm from the roof and, where possible, in water flow direction, so that rainwater can drain unhindered (refer to V. Electrical installation: Cable trays).

The DAS Energy PV modules are intended to be bonded directly onto a roofing membrane or roof sheeting, or, alternatively, onto a supporting sub-construction. For this purpose, please follow the bonding instructions by Innotec (refer to Bonding instructions, Art. no. 199131-2). Use only the from DAS Energy and Innotec prescribed adhesives "Versabond Photovoltaic" or "Adheseal Photovoltaic" as well as the cleaning agent "Multisol Project" with the cleaning cloth "Multi Wipes", all from Innotec. Note the processing temperature of the adhesive and the temperature of the substrate. Make sure the substrate as well as the backside of the PV module is dry and free of dust and grease before gluing (e.g. rust, old paint, etc. must be removed upfront). With the following QR codes training videos for the appropriate installation of the DAS Energy PV modules via bonding can be found.

Bonding on plastic roof sheetings



Bonding on bitumen roofing membranes



Bonding on metal sub-constructions



In any case, do not modify the module backside!
Plug & socket must not get into contact with the cleaning agent Multisol Project!

Disclaimer: A claim under warranty solely exists when the from DAS Energy and Innotec prescribed adhesives are used and processed in accordance with the bonding instructions by Innotec. In addition, please note that the mounting via bonding inevitably leads to irreversible or difficulty repairable modifications of the substrate the modules are bonded on. DAS Energy is not liable for possible damages to the substrate due to the assembly or rather disassembly of the modules.

MOUNTING OF MODULES WITH MOUNTING HOLES

The mounting of DAS Energy PV modules via screw connections is possible under the prerequisite that the modules have mounting holes or eyelets. The modules should be mounted in a way that they are fixed and immobile and do not provide contact surface for the wind. Otherwise there is the danger of cell breakages.



The subsequent drilling of modules (even in the peripheral areas of the laminate) is inadmissible unless it was declared with order and the modules are fabricated with an appropriate wider peripheral zone.

For specific cases, the DAS Energy PV modules can be fabricated with an appropriate wider peripheral zone so that subsequent drilling is admissible. If the modules have no mounting holes ex-works, any subsequently drilled mounting holes must always be engineered in accordance with the local requirements (e.g. wind and snow loads).



The minimum distance of 12 mm from mounting holes to electrically conductive components, like cells or cell connectors (see Fig. 3) must always be observed.

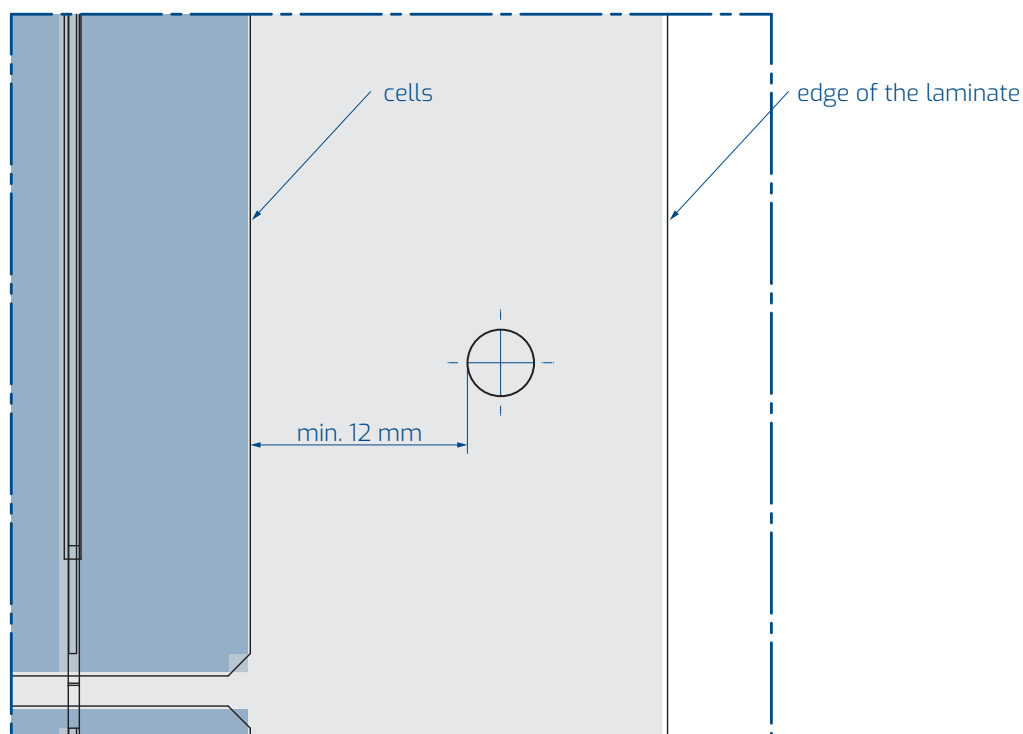

Fig. 3:
Minimum distance between
subsequently drilled mount-
ing holes and electrically
conductive components

Disclaimer: DAS Energy is not liable for any damage to the modules or the substrate/sub-construction arising from insufficient mounting and fastening or inadmissible mounting holes.

V. ELECTRICAL INSTALLATION

A photovoltaic module behaves under solar irradiation like a direct-current generator (e.g. like a battery) and therefore has a positive and a negative contact. Depending on the irradiance hazardous voltages may occur!

SYSTEM COMPONENT DIMENSIONING

The rated electrical characteristics such as I_{SC} , V_{OC} and P_{MPP} are measured within 3 % of measurement uncertainty at Standard Test Conditions (1,000 W/m², 25 ± 2 °C, AM 1.5). Under normal conditions, a photovoltaic module is likely to experience conditions that produce more current and/or voltage than reported at STC (Standard Test Conditions). Accordingly, the values of I_{SC} (short-circuit current) and V_{OC} (rated open-circuit voltage) marked on this module should be multiplied by a factor of 1.25 when determining component voltage ratings, conductor ampacities, fuse sizes, and size of controls connected to the PV output.

The safety factor of 1.25 for the minimum voltage rating of the components can be modified during the design of a system according to EN 62548 "Photovoltaic (PV) arrays – Design requirements" based on the lowest expected operating temperature at the location of the installation and the temperature coefficient for V_{OC} . I_{SC} can be adjusted based on maximal temperature, irradiance and orientation of the module. To this end a full simulation for the specific location is required using long-term weather data.

A solar power plant consists of one or more module strings in parallel, depending on the size or rather total system power. These module strings consist of several PV modules connected in series. The fundamental inter-connection options for the PV modules are illustrated in Fig. 4. When modules are connected directly in series (a), voltages are additive, and when modules are connected directly in parallel (b), module currents are additive.

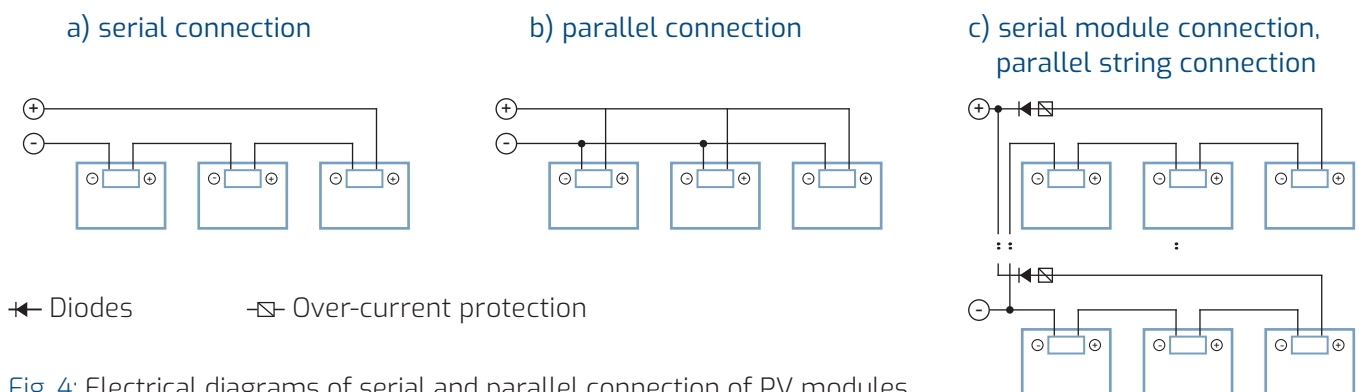

Fig. 4: Electrical diagrams of serial and parallel connection of PV modules

The maximum number of PV modules that can be connected in a series string must be calculated in accordance with applicable regulations in such a way that the specified maximum system voltage of the modules (1,000 V_{DC}) and all the other electrical DC-side components will not be exceeded in open-circuit operation at the lowest expected operating temperature at the PV system location. Therefore, the correction factor for the open-circuit voltage of 1.25 by default can be modified and calculated as follows: $C_{Voc} = 1 - \beta_{Voc} \times (25 - T)$. Hereby, T is the lowest expected ambient temperature in °C at the system location and β_{Voc} is the temperature coefficient in %/°C (refer to the corresponding datasheet).

An appropriately rated over-current protection device is required when the reverse current could exceed the value of the maximum fuse rating of the PV modules (20 A). Therefore, if more than two series strings are connected in parallel, an appropriate over-current protection device by means of particular PV DC fuses (15 A) must be used in any case for each series string, as illustrated in Fig. 4 c).

INVERTER

Inverters with or without transformers (with or without galvanic isolation) may be used. Follow the guidelines of the inverter manufacturer. In any case, the total open circuit voltage (which is the maximum possible voltage that can occur) of the solar generator corrected for the lowest expected operating temperature, must be below the maximum input voltage of the inverter.

CABLES AND WIRING

The junction boxes of DAS Energy PV modules have been designed to be easily interconnected in series. Each PV module has two single-conductor wires, one positive and one negative, which are pre-wired inside the junction box. The PV connectors at the opposite end of these wires allow easy series connection of adjacent modules by firmly mating the positive connector of one module with the negative connector of an adjacent module.



Solely wire PV modules of the same type or with different orientation or inclination to the same string. For special applications which require different module types please consult DAS Energy.

The DC-side cables shall have a sufficient cross-section to limit the resulting voltage drop to 1 % of the voltage in the MPP (maximum power point) maximum. Additionally, the insulation must be approved for the maximum system open circuit voltage. Always use specific cables for photovoltaic installations, resistant to atmospheric agents and qualified for direct current (DC) wiring in PV systems. The recommended minimum wire size should be 4 mm².

The cable routing should be done in such a way that mechanical damage of the cable as well as the connectors and/or the modules is avoided. Do not apply stress to the cables and ensure that the cables are not under stress after installation. The cable must not be bent or crushed on the direct exit of the cable screw joint. A minimum bending radius $R \geq 5 \times \text{Cable diameter}$ must be maintained (see Fig. 5). Despite the cables are sunlight resistant and waterproof (protection class IP 68), where possible, place the cables in cable ducts in order to avoid direct sunlight exposure and water immersion. For fixing, use appropriate means, such as sunlight resistant cable ties and/or wire management clips.



Fig. 5: permissible bending radius of the solar cables

(Source: Application Specification 114-137167: Solarlok PV BAR Junction Box Assemblies, 21 November 2018 Rev. D, TE Connectivity)

Disclaimer: DAS Energy is not liable for any damage to the cables or the modules, in particular the junction box, arising from inadmissible cable bending, improper cable routing or inadmissible handling during installation (please obey national regulations!).

CONNECTORS

The DAS Energy PV modules are equipped with PV connectors from the type "SOLARLOK PV4-5" from TE Connectivity (TE). The connectors are designed for an easy and fast connection without any special tool. Despite the connectors are sunlight resistant and waterproof (protection class IP 68), avoid direct sunlight exposure and water immersion, where possible.



Always keep the connectors dry and clean. Any kind of pollution (dust, humidity, foreign particles etc.) during the assembly process can degrade contact and connectors performance. A clean assembly environment is therefore essential. Unconnected connectors must always be protected from pollution (e.g. dust, humidity, foreign particles, etc.), prior to installation. Do not leave unconnected (unprotected) connectors exposed to the environment. Therefore, remove the protective dust caps from the connectors only just before the electrical connection. Plugs and junction boxes must not get into contact with the Multisol Project cleaning agent!



Do not attempt to make an electrical connection with wet, soiled, or otherwise faulty connectors. Faulty connections can result in arcs and electrical shock. Check that all electrical connections are securely fastened and make sure that all locking connectors are fully engaged and locked.

COMPATIBILITY

According to IEC 62548, plugs and socket connectors mated together in a PV system shall be of the same type from the same manufacturer. Thus, it is not allowed to connect the pre-assembled "SOLARLOK PV4-5" connectors of the DAS Energy PV modules with connectors from another type and/or another manufacturer. Please observe the following compatibility list of compatible connectors:

COMPATIBILITY LIST OF CONNECTORS (TABLE 1)			
PRODUCT NAME	PART NUMBER	MANUFACTURER	APPLICATION
PV4-5 CONNECTOR KIT PIN-MALE (with pin-contact), 4 mm ² - 6 mm ² (AWG 12-10)	2270024-1	TE Connectivity	cable application
PV4-5 CONNECTOR KIT PIN-MALE (with pin-contact), 2.5 mm ² (AWG 14)	2270024-3	TE Connectivity	cable application
PV4-5 CONNECTOR KIT SOCKET-FEMALE (with socket-contact), 4 mm ² - 6 mm ² (AWG 12-10)	2270025-1	TE Connectivity	cable application
PV4-5 CONNECTOR KIT SOCKET-FEMALE (with socket-contact), 2.5 mm ² (AWG 14)	2270025-3	TE Connectivity	cable application
PV4-PM CONNECTOR KIT PIN-MALE (with pin-contact), 4 mm ² - 6 mm ² (AWG 12-10)	1971919-1	TE Connectivity	panel mount application
PV4-PM CONNECTOR KIT PIN-MALE (with pin-contact), 2.5 mm ² (AWG 14)	1-1971919-1	TE Connectivity	panel mount application
PV4-PM CONNECTOR KIT SOCKET-FEMALE (with socket-contact), 4 mm ² - 6 mm ² (AWG 12-10)	1971920-1	TE Connectivity	panel mount application
PV4-PM CONNECTOR KIT SOCKET-FEMALE (with socket-contact), 2.5 mm ² (AWG 14)	1-1971920-1	TE Connectivity	panel mount application
SOLARLOK 2.0 Pin Connector	2315176-1	TE Connectivity	cable application
SOLARLOK 2.0 Socket Connector	2308033-1	TE Connectivity	cable application

CONNECTOR REPLACEMENT

In certain cases, it might be necessary to replace the pre-assembled PV4-5 connectors of the DAS Energy PV modules by connectors from another type and/or manufacturer in order to maintain the compatibility requirements according to IEC 62548 and this manual. The replacement of the pre-assembled PV4-5 connectors is permitted without the loss of warranty only under the following conditions:

CONDITIONS FOR PERMITTED CONNECTOR REPLACEMENT:

INCOMPATIBLE CONNECTORS OF THE SYSTEM WIRING

In case the solar cables of the system wiring are equipped with incompatible connectors (refer to Tab. 1), the connectors of the PV modules at the beginning and at the end of each module string may be replaced by compatible connectors (see Fig. 6). Nevertheless, the replacement of the system wiring connectors or rather the appropriate choice of connectors in advance should always be prioritized in order to avoid the replacement of the pre-assembled connectors.



INCOMPATIBLE CONNECTORS OF POWER OPTIMIZERS/MICRO-INVERTERS

In case system components downstream from the PV modules, such as power optimizers or micro-inverters, are equipped with incompatible connectors (refer to Tab. 1), the connectors of each PV module may be replaced by compatible connectors. Nevertheless, the right choice of components with compatible connectors in advance should always be prioritized in order to avoid the replacement of the pre-assembled connectors. Most manufacturers of such module-addon components can provide their products with compatible PV4-5 components upon request.

DAMAGED PV4-5 CONNECTORS

In case the pre-assembled PV4-5 connectors are damaged by inadmissible handling, transport, storage, or maintenance of the modules they may be replaced by functioning connectors. In that case, DAS Energy must always be consulted in advance. Only after verification and confirmation from DAS Energy the replacement of the damaged PV4-5 connectors is permitted.

In case the PV4-5 connector should be replaced, it can be removed by simply cutting the solar cable. To assemble the alternative connector please follow the guidelines and instructions of the connector manufacturer. In any case, before the replacement of a connector, the compatibility and applicability of the alternative connector must be verified.



Do not attempt to replace a connector while the corresponding PV module is connected to other PV modules or rather a module string, or other electrical components. The assembly of a connector requires to cable strip the solar cable and thereby makes it accessible to direct contact.

For the assembly of PV4-5 connectors please refer to Application Specification 114-137077: PV4-5/S1 Connector, 15 April 2020 Rev. A10, TE Connectivity, for the assembly of SOLARLOK 2.0 DC-connectors please refer to Application Specification 114-133104: SOLARLOK 2.0 Family, Insulation Displacement Contact (IDC), 14 MAY 19 Rev. A1.

Disclaimer: In case of a connector replacement, the warranty applies only to the functionality of the DAS Energy PV module under exclusion of the connector which has been replaced. DAS Energy is not liable for any damage resulting from improper assembly or non-compliance with the instructions for assembly and installa-

CONNECTORS MATING

It is only allowed to connect a plus (+) coded connector to a minus (-) coded connector. Connectors with identical polarity mark are not allowed to couple (forbidden to use + on + or - on -). The polarity of the connectors is indicated on their housing (see Fig. 7).

Mating of the connectors is done by pushing the connectors together until a clear audible click is heard. This clear audible clicking sound must be heard to ensure the connectors have been mated correctly. When the connectors are correctly connected the latches should be flush against the edge of the connector (see Fig. 8).

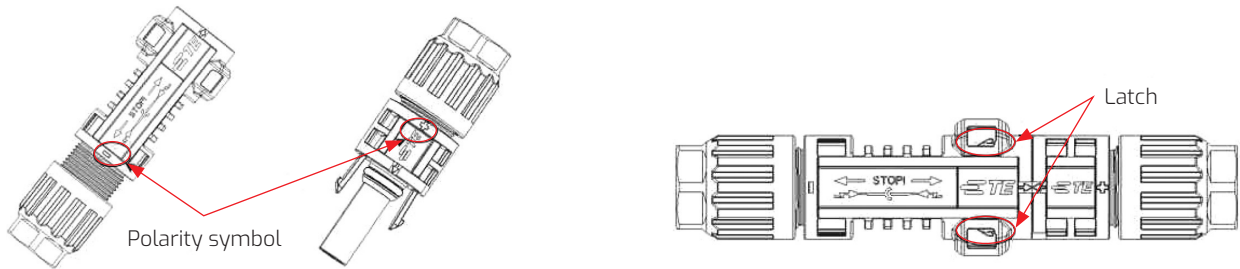

Fig. 7: Indication of polarity of the PV4-5 connectors Fig. 8: Mating the PV4-5 connectors

DISCONNECTING

Please use the corresponding TE connectivity PV4-5 hand application tool (PN 1971903-1) for disconnecting the PV4-5 coupler connection. Without this tool there is the potential of damage to the PV4-5 connectors of both male and female.

 **Never open the PV4-5 connectors while the wires are current-carrying! Connectors are designed to be opened without any load.**

The locking mechanism of the PV4-5 coupler connection is opened by depressing the latches with the hand application tool as shown in Fig. 9. Then, disconnect the coupler connection while the special tool insertion into the locking mechanism to depress the latches, and pull the couplers apart. Attention: Open couplers must be protected against the penetration of dirt and dust by means of protective dust caps.



Fig. 9: Disconnecting the PV4-5 coupler connection

(Source: Application Specification 114-137077: PV4-5/S1 Connector, 11 OCT 2018 Rev. A7, TE Connectivity)

CABLE TRAYS

The installation method of direct bonding of DAS Energy PV modules on a roofing membrane implies that the cabling cannot be done behind the modules. Thus, it is required to use cable trays in order to avoid direct sunlight exposure and water immersion.

The cable trays should be installed with a spacer (concrete slabs, protective mats or similar) between the roof and the cable tray (see Fig. 10) and, if possible, in water flow direction, so that the rainwater can drain unhindered and no pressure load occurs at the cable trays due to rainwater or snow. Hereby a minimum distance of 10 mm and/or the local requirements, respectively, must be observed. In any case the installer should ensure compliance with the appropriate standards. Local legislation and local applicable wind and snow load tables must be observed, and appropriate measures must be taken to ensure the resistance of the cable trays against wind and snow load as well as ice pressure.



Fig. 10: Example of a cable tray, which is distanced from the roof



The cable trays must not be left open.

EARTHING / LIGHTNING PROTECTION

The DAS Energy modules correspond to safety class II in accordance with IEC 61140 "Protection against electric shock" and safety application class A in accordance with IEC 61730 "Photovoltaic (PV) module safety qualification" and do not require any grounding. The DAS Energy photovoltaic modules exceed the normative insulation requirements of $40 \text{ M}\Omega \text{ m}^2$ significantly and do not have any conducting frame.

PROTECTIVE GROUNDING

The DAS Energy modules correspond to safety class II and do not have any accessible conductive parts or frames and do not need to be grounded.

FUNCTIONAL GROUNDING / POTENTIAL INDUCED DEGRADATION (PID)

The DAS Energy modules do not suffer from PID due to the unique material composition; therefore, it is not necessary to functionally ground the negative generator pole. Nevertheless, negative generator pole grounding is possible with DAS Energy modules. In this case, only use inverters which include licensed grounding kits and follow the directions of the inverter manufacturer (make sure that the difference of potential between the negative generator connection and the PE(N) of every MPP tracker of the respective inverter is zero volt).

ANTI-LIGHTNING PROTECTION

The DAS Energy modules do not have any accessible conductive parts or frames and hence cannot be incorporated into the possibly available lightning protection. Nevertheless, it is necessary to observe the required separation distances to a possibly available lightning protection. We recommend to involve a corresponding special consultant. Please also observe – possibly depending on the lightning protection concept – the current standards and directives for overvoltage protection on the DC-side of the solar generator and inverter as well as on the AC-side (grid connection) of the inverter.

VI. OPERATION AND MAINTENANCE

Regular maintenance of the modules is not mandatory. However, it is recommended to perform regular inspection and maintenance of the PV modules.

VISUAL INSPECTION

The PV modules should be inspected visually for any damage or other conspicuous features. In particular the module surface as well as the junction box need special attention. Additionally, the electrical connections should be examined for loose connections or other conspicuous features.

CLEANING

The DAS Energy PV modules operate efficiently even if they are never cleaned. Due to the special soil-resistant surface of the DAS Energy modules, dirt and grime are usually washed away by rain. Nevertheless, the output power can be increased by removing dirt on the module surface. Dust, dirt, or other residue on the module surface can be regularly washed away with water. Stubborn dirt can be removed with a soft cloth (dry or moist with lukewarm water).

Please observe the following:

- Avoid cleaning the modules on hot sunny days, in the middle of the day or when there is high irradiation levels and high temperatures. The module temperature should be between 10° and 30 °C.
- Do not use micro-fiber cloths, scrapers (or other metal tools), or high-pressure water cleaners.
- Do not use aggressive cleaning agents, abrasive cleaners, tensides or other chemicals.
- Remove snow and ice without force (e.g. with a very soft broom in order not to damage the protective layer of the photovoltaic module).
- Always wear rubber gloves whilst servicing, washing, or cleaning the modules to insulate and protect yourself from electric shock.

MODULE REPLACEMENT / DISMANTLING

In case of damages or defects of the modules their dismantling or rather replacement may be necessary. The dismantling of DAS Energy modules is possible at both screw-fastened mounting and bonded mounting.



Before the dismantling of certain module or any other modification of the PV system please make absolutely sure that the electrical system is without voltage and secured against unauthorized activation. The electrical connectors may never be disconnected under load. Non-compliance can be highly dangerous!

Disclaimer: DAS Energy is not liable for any damage to the substrate, on which the modules are bonded on, or the modules themselves resulting from the dismantling of certain modules.

DISCONNECTING THE PV4-S COUPLER CONNECTION

Disconnect the PV4-S coupler connections of the PV module which should be dismantled or rather replaced with the connected, adjacent PV modules according to V. Electrical installation: Connectors.

MECHANICAL DISMANTLING

In case the module is supposed to be installed and operated again after dismantling, please pay attention not to sharply bend or apply focused pressure on the module during the dismantling.

Modules, which are fixed on a substrate or a sub-construction with a screw connection can easily be dismantled after disconnecting the PV4-5 coupler connection.

Modules, which are mounted via bonding can be dismantled by means of a cutting wire with which the adhesive beads (as well as possibly available fixation tape) can be cut lengthwise and through the center. DAS Energy recommends a cutting wire with the specifications listed in Tab. 2. To cut the bonding, please pull the cutting wire between the module and the substrate lengthwise through the adhesive beads, as shown in Fig. 11. Take care here not the damage adjoining modules. Afterwards, the module can be detached from the substrate.

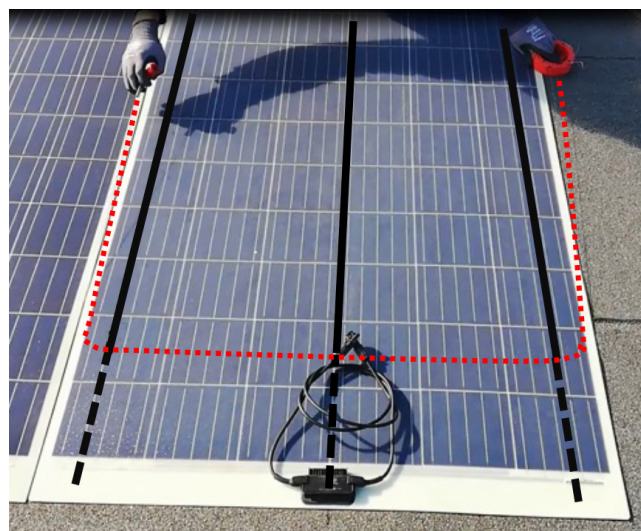
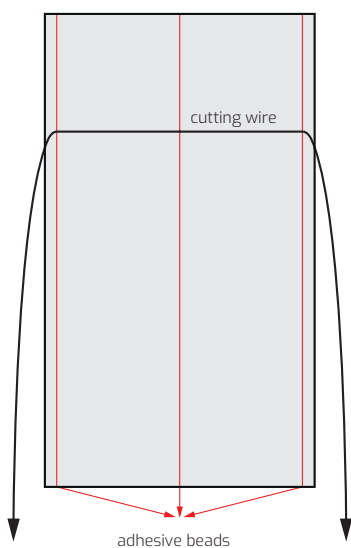

Fig. 11: Dismantling of bonded modules by means of a cutting wire

SPEZIFIKATION DES EMPFOHLENE SCHNEIDRAHTS (TABELLE 2)

Width	0,6 mm
Height	0,6 mm
Form	Square-cut
Material	Stainless steel
Edge radius	0,1 mm

MOUNTING OF A SPARE MODULE

After the dismantling of a module a spare module can be installed on the vacant place without removing the remains of the cut adhesive beads. Therefore, please apply the new adhesive beads just beside the remains of the old ones and proceed as described in the section IV. Module installation: Mounting via bonding.



Please make sure the spare module is of the same type as the defect/ dismantled module. Solely modules of the same type should be connected to a string.

VII. DISPOSAL

DAS Energy photovoltaic modules are electrical apparatus and must be disposed of accordingly & in obedience of the laws of the country of installation. They must not be disposed of with household waste but according to the valid disposal regulations for electronic scrap. In case of disposal questions, please contact our sales department.

VIII. POTENTIAL SOURCES OF FAULTS

In Tab. 3 the potential sources of faults are listed, which may arise out of improper handling during the installation or operation of DAS Energy modules, as well as instructions to avoiding these errors.

POTENTIAL SOURCES OF FAULTS (TABLE 3)	
POTENTIAL SOURCES OF FAULTS	INSTRUCTIONS TO AVOIDING ERRORS Cell
Cell breakage	<ul style="list-style-type: none">· Handling should be done by two persons· Turn the modules out of the wind (do not provide an attack surface for the wind and do not turn the module like a sail in the wind)· Do not step on the modules· Store modules (especially on construction sites) in wind and weather resistant environment
Problems with gluing	<ul style="list-style-type: none">· Note the processing temperature of the adhesive· Note the temperature of the substrate· The substrate must be dry and free of dust and grease before gluing (e.g. rust, old paint, etc. must be removed before)· The backside of the module must be free of dust and grease
Constant humidity & dirt	<ul style="list-style-type: none">· Note the water flow direction· Identify and, if possible, leave out recurring sources of dirt· Apply adhesive beads in water flow direction· Install the cable tray at a distance of at least 10 mm from the roof and in water flow direction, so that the rainwater can drain unhindered
Shading & orientation	<ul style="list-style-type: none">· Avoid shading sources (cable trays!)· Remove concentrated dirt accumulations from the module surface
Linear expansion	<ul style="list-style-type: none">· Observe a minimum distance of ~5 mm (synthetic roof sheeting) or rather ~10 mm (bituminous roof sheeting) between the modules
Damaged module surface	<ul style="list-style-type: none">· Do not lay down the modules on rough, abrasive undergrounds.· Do not use metal tools (like scrapers) or high-pressure cleaners as well as aggressive cleaning agents, abrasive cleaners, tensides or other chemicals for cleaning the modules

IX. TECHNICAL DETAILS

PRODUCT MARKING, PRODUCT LABEL

The product label is placed on the module backside and contains all required important electrical and product specific values. The information on the label relates to Standard Test Conditions (1,000 W/m², 25 ± 2 °C, AM 1.5 according to IEC 60904-3). Further technical information is available on the product specific data sheets.



The product label must not be damaged or removed – otherwise the guarantee and product warranty will be invalidated!

SAFETY APPLICATION CLASS

The module is certified for the Safety Application Class A (general access, hazardous voltage, and hazardous power applications) according to IEC 61730.

FIRE SAFETY CLASS

The DAS Energy PV modules are tested and certified for fire safety class C according to IEC 61730-2 and B_{ROOF}(t1) according to EN 13501-5. The fire rating of this PV modules is valid only when mounted in the manner specified in the mechanical mounting instructions (refer to IV. Module installation).

MODULE SPECIFICATIONS

Please find below the datasheet of the module types to which this manual is applicable. The module types are subject to changes without prior notice due to continuous product innovation, research, and development.

DO NOT STEP ON THE MODULES

The PV system shall be marked in a suitable place with the notice stickers "Do not step on the modules".



THE UNIVERSAL MODULE

- 
ULTRA-LIGHTWEIGHT
 Only 3.3 kg/m²

 - 
HIGH-EFFICIENCY SILICON CELL
 Monocrystalline cells
 No thin film!

 - 
UNIQUE "LOW DEGRADATION" WARRANTY
 Minimum 85 % yield after 40 years

 - 
PATENTED MULTI-LAYER CELL ENCAPSULATION
 Maximal microcrack protection
 Increased longevity

 - 
ETFE FRONT SHEET
 Soil-repellent (high self-cleaning effect)
 UV & salt resistant
 Optimal heat dissipation

 - 
HIGH YIELD IN ANY POSITION
 Multi-directional lens structure
- 
BENDABLE
 Smallest bending diameter (2 m)

 - 
EASY TO INSTALL
 Simple but strong adhesive bonding
 No metal subsystem required
 No ballast required

 - 
TAILOR-MADE OPTIONS AVAILABLE
 Sizing to your requirement
 Transparent back sheet

 - 
EXTREME WEATHER CONDITIONS
 Even in heat, sandstorms and dusty conditions, the module provides stable and durable performance

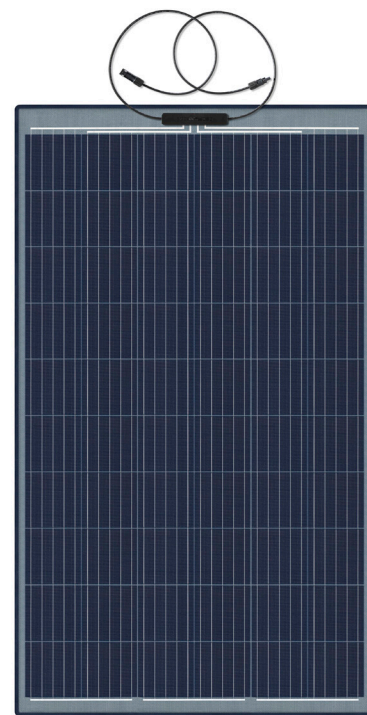
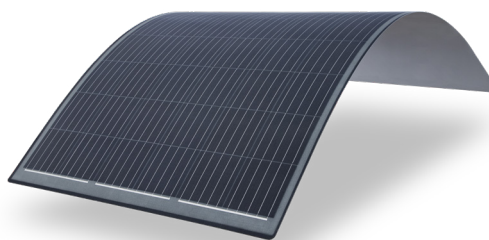

TEMPERATUREEIGENSCHAFTEN

Betriebstemperaturbereich	-40°C to +85°C
Temperaturkoeffizient von P _{mpp}	-0.38 % / °C
Temperaturkoeffizient von V _{oc}	-0.36 % / °C
Temperaturkoeffizient von I _{sc}	+0.07 % / °C

TECHNISCHE DATEN

Solarzellen	5BB monocrystalline solar cells
Maximale Systemspannung	1000 V
Rückstrombelastbarkeit	20 A
I _{sc}	9.28 A
I _{mp}	8.86 A
Gewicht	3.3 kg/m ²
Vorderseite	Schmutzabweisende ETFE
Zelleinbettung	Patentierter glasfaserverstärkter Kunststoff
Rückseite	Hochbeständiges PET
Anschlussdose	TÜV-zertifiziert (IP67/68) mit Bypass-Dioden
Kabel	2 x 4 mm ²
Stecker	PV4-S

THE UNIVERSAL MODULE

Available standard sizes

ULTRA-LIGHTWEIGHT

HIGH-EFFICIENCY SILICON CELL TECHNOLOGY

UNIQUE "LOW DEGRADATION" WARRANTY

PATENTED MULTI-LAYER CELL ENCAPSULATION

ETFE FRONT SHEET

HIGH YIELD IN ANY POSITION

BENDABLE

EASY TO INSTALL

TAILOR-MADE OPTIONS AVAILABLE

EXTREME WEATHER CONDITIONS



Length FJB & RJB	2035 mm	12	12 x 1 M 60 Wp 8,25 Voc 6,83 Vmp	12 x 2 M 120 Wp 16,50 Voc 13,67 Vmp				
	1917 mm	11	11 x 1 M 55 Wp 7,56 Voc 6,26 Vmp	11 x 2 M 110 Wp 15,13 Voc 12,53 Vmp	11 x 3 M 165 Wp 22,69 Voc 18,80 Vmp	11 x 4 M 220 Wp 30,26 Voc 25,06 Vmp	11 x 5 M 275 Wp 37,83 Voc 31,33 Vmp	11 x 6 M 330 Wp 45,39 Voc 37,60 Vmp
	1756 mm	10	10 x 1 M 50 Wp 6,87 Voc 5,69 Vmp	10 x 2 M 100 Wp 13,75 Voc 11,39 Vmp	10 x 3 M 150 Wp 20,63 Voc 17,09 Vmp	10 x 4 M 200 Wp 27,51 Voc 22,78 Vmp	10 x 5 M 250 Wp 34,39 Voc 28,48 Vmp	10 x 6 M 300 Wp 41,26 Voc 34,18 Vmp
	1595 mm	9	9 x 1 M 45 Wp 6,19 Voc 5,12 Vmp	9 x 2 M 90 Wp 12,38 Voc 10,25 Vmp	9 x 3 M 135 Wp 18,57 Voc 15,38 Vmp	9 x 4 M 180 Wp 24,76 Voc 20,50 Vmp	9 x 5 M 225 Wp 30,95 Voc 25,63 Vmp	9 x 6 M 270 Wp 37,14 Voc 30,76 Vmp
	1434 mm	8	8 x 1 M 40 Wp 5,50 Voc 4,55 Vmp	8 x 2 M 80 Wp 11,00 Voc 9,11 Vmp	8 x 3 M 120 Wp 16,50 Voc 13,67 Vmp	8 x 4 M 160 Wp 22,01 Voc 18,23 Vmp	8 x 5 M 200 Wp 27,51 Voc 22,78 Vmp	8 x 6 M 240 Wp 33,01 Voc 27,34 Vmp
	1274 mm	7	7 x 1 M 35 Wp 4,81 Voc 3,98 Vmp	7 x 2 M 70 Wp 9,62 Voc 7,97 Vmp	7 x 3 M 105 Wp 14,44 Voc 11,96 Vmp	7 x 4 M 140 Wp 19,25 Voc 15,95 Vmp	7 x 5 M 175 Wp 24,07 Voc 19,93 Vmp	7 x 6 M 210 Wp 28,88 Voc 23,92 Vmp
	1113 mm	6	6 x 1 M 30 Wp 4,12 Voc 3,41 Vmp	6 x 2 M 60 Wp 8,25 Voc 6,83 Vmp	6 x 3 M 90 Wp 12,38 Voc 10,25 Vmp	6 x 4 M 120 Wp 16,50 Voc 13,67 Vmp	6 x 5 M 150 Wp 20,63 Voc 17,09 Vmp	6 x 6 M 180 Wp 24,76 Voc 20,50 Vmp
	Thickness 2 mm ± 0.3			1	2	3	4	5
			227 mm	377 mm	548 mm	699 mm	870 mm	1020 mm
			Width					

RJB = rear junction box FJB = front junction box

APPLICATIONS

Building-integrated and building-applied PV (rooftop, facade), special applications

POWER RANGE 20 - 350 Wp

Tolerances*
 ≥ 250 Wp: - 0 / + 10 W
 < 250 Wp: - 5 / + 5 W
 Ics: +/- 10 %
 Voc: +/- 10 %

* all electrical data at STC (1.000 W/m², 25 +/- 2 °C, AM 1.5 according to IEC 60904-3)

HIGH RELIABILITY

IEC 61730 | IEC 61215
 IEC 62804-1 Potential-induced degradation
 IEC 61701 Salt mist corrosion
 IEC 62716 Ammonia corrosion
 EN 13501-5 B_{ROOF} (t1) *Flying sparks test"

WARRANTY

10-year product warranty
 40-year linear performance warranty for building-integrated and building-applied installations

SCIENTIFIC PARTNERS AND ASSOCIATIONS



Phone / +43 2622 35035 0
 E-Mail / office@das-energy.com
 Web / www.das-energy.com

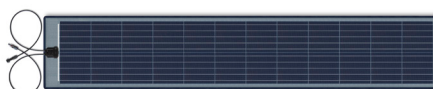

Ferdinand Graf von Zeppelin-Straße 18
 2700 Wiener Neustadt, Austria

EU Declaration of Conformity
EU Konformitätserklärung
Directive 2014/35/EU (Low Voltage Directive)
Richtlinie 2014/35/EU (Niederspannungsrichtlinie)

The manufacturer
Der Hersteller
DAS Energy GmbH
Ferdinand Graf von Zeppelin Straße 18
A-2700 Wiener Neustadt
Austria

declares herewith, that the following product series
erklärt hiermit, dass die folgende Produktserie

2x2P to 12x6P
2x2M to 12x6M

Fulfil the requirements of the international standards
mit den Anforderungen der internationalen Normen

EN IEC 61730-1:2018

Photovoltaic (PV) module safety qualification - Part 1: Requirements for construction
Photovoltaik (PV)-Module — Sicherheitsqualifikation — Teil 1: Anforderungen an den Aufbau

EN IEC 61730-2:2018

Photovoltaic (PV) module safety qualification - Part 2: Requirements for testing
Photovoltaik (PV)-Module — Sicherheitsqualifikation — Teil 2: Anforderungen an die Prüfung

and therefore, corresponds to the regulations of the EU-Directive 2014/35/EU
übereinstimmen und damit den Bestimmungen der EU-Richtlinien 2014/35/EU entsprechen.

Wiener Neustadt, 30.03.2021



DAS Energy GmbH
Ferdinand Graf von Zeppelin Str. 18
2700 Wiener Neustadt · AUSTRIA
office@das-energy.com · www.das-energy.com
+43 (0)2622 735 035

Christian Dries
Managing Director
Geschäftsführer



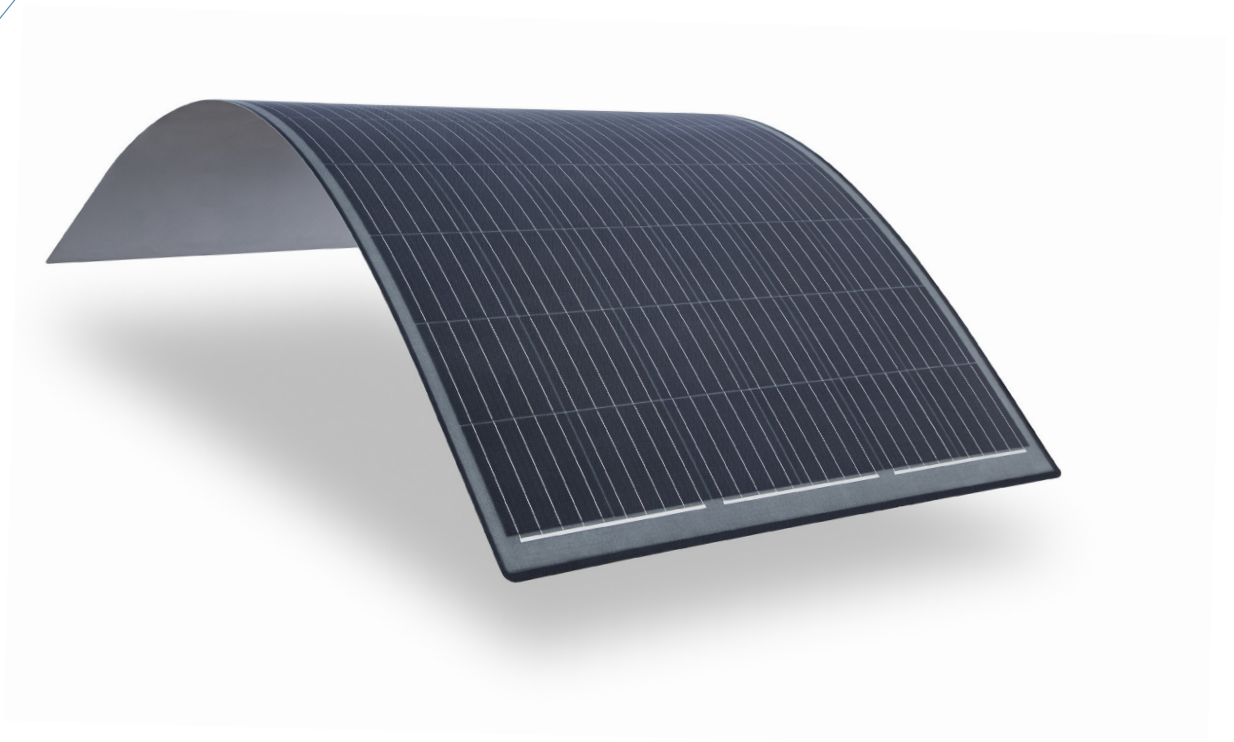

**CONTACT US TO
START YOUR PROJECT**

Ferdinand Graf von Zeppelin-Straße 18
2700 Wiener Neustadt, Austria

Phone: +43 2622 35035 0
E-Mail: office@das-energy.com
Web: www.das-energy.com

